

EC DECLARATION OF CONFORMITY



No. 2501

The undersigned manufacturer:

Gonge Creative Learning ApS, Rygesmindevej 2, DK 8653, Them

www.gonge.com

Herewith declares that the product:

Gonge model no. 2501
Color: Black/grey



Is in conformity with the provisions of the following EC directive(s), including all applicable amendments.

Reference no.	Title
Directive 2009/48/EC	Toy Safety Directive

The standards and/or technical specifications mentioned below have been applied.

Harmonized standards	Notified body	Certificate/ technical report
EN71-1:2014 + A1:2018 EN71-2:2020 EN71-3:2019 + A1:2021 REACH Entry 51 & 52 - phthalates	Eurofins Testing Technology (Shenzhen) Co. Ltd.	EFSN20030065C-C

This declaration of conformity is issued under the sole responsibility of the manufacturer.

Them 07-01-2022

Anne Margrethe Enné Signature

Anne Margrethe Enné – Technical Documentation

Name and function of the signatory empowered to bind the manufacturer.

SWNX | INSTRUCTION MANUAL

PACKAGE CONTENT

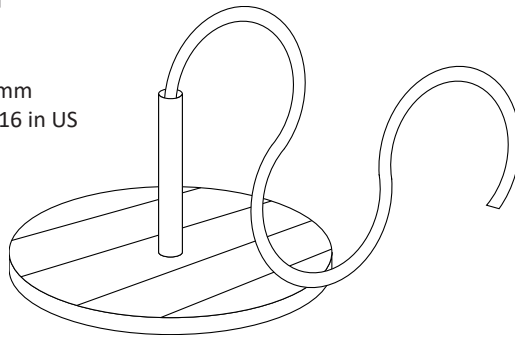
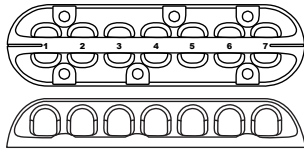
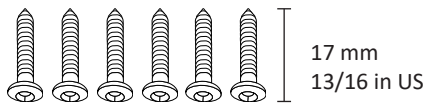

4 Screws (tx20), 1 pc. Mount, 1 pc. SWNX

Mounting requires additional tools: 1 pencil + screwdriver.
Attention: Table thickness should be over 20 mm (13/16 in US)

1.

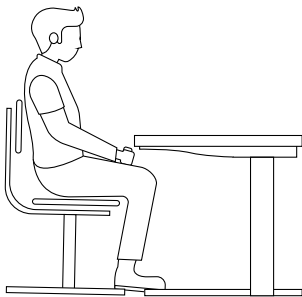

Sit at the table.

2.

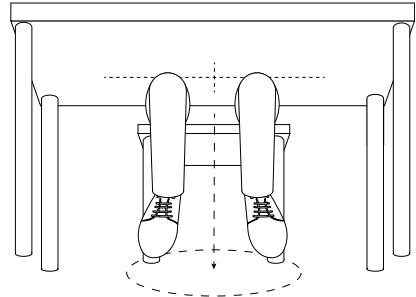

Mark the position of the knees under the table.
Centered between the knees.

3.

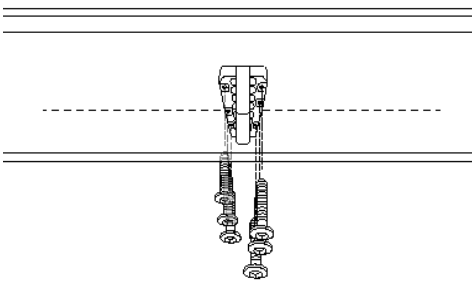

Mount the bracket with 4 screws.

4.

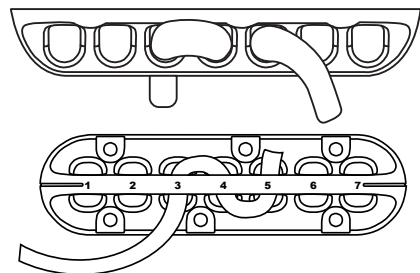

Attach SWNX to the bracket.

5.

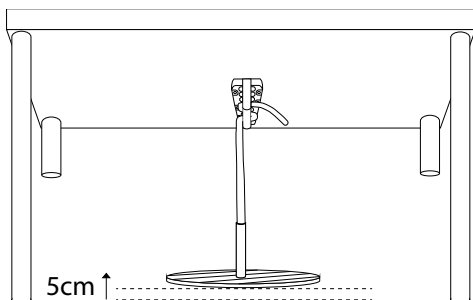

Adjust so that the foot rest hangs
50 mm (2 in US) parallel above the floor.

SwNX[®]

Patent by Resense
CVR: DK38500392
www.swnx.dk